

125 K

8t

LIEBHERR Fast-Erecting Tower Crane

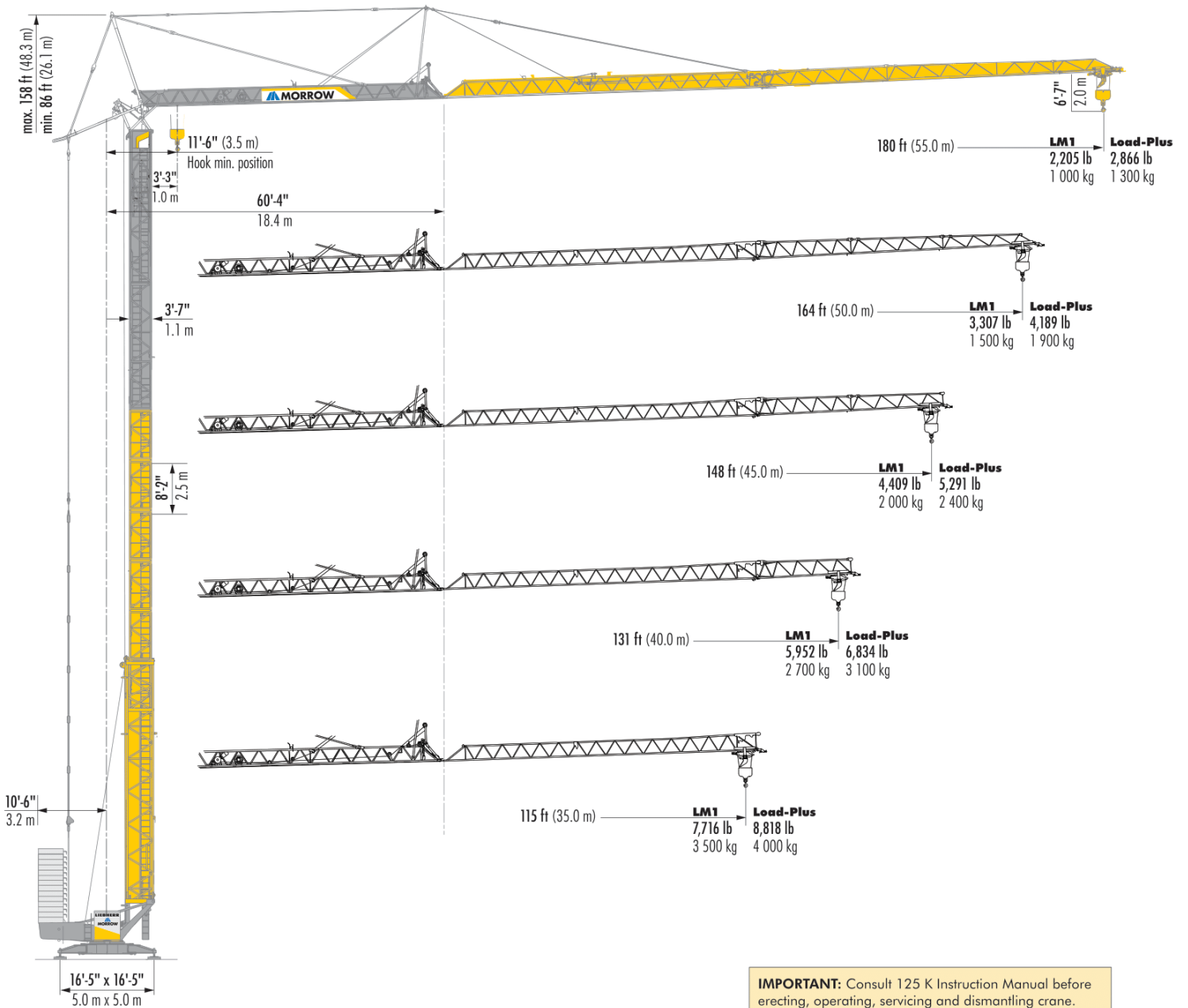

IMPORTANT: Consult 125 K Instruction Manual before erecting, operating, servicing and dismantling crane.

LIEBHERR 125 K

Tower Configurations

The highly adaptable **125 K fast-erecting crane**, with 10 hook heights for added flexibility and functionality. The graphic on this and the adjoining page illustrates the 10 tower configurations, starting with tower fully retracted and supported by the strut forks (**Configuration 1**), three intermediate positions supported by the strut forks (**Configurations 2-4**) and with tower completely extended, supported by the automatic tower locking mechanism (**Configuration 5**).

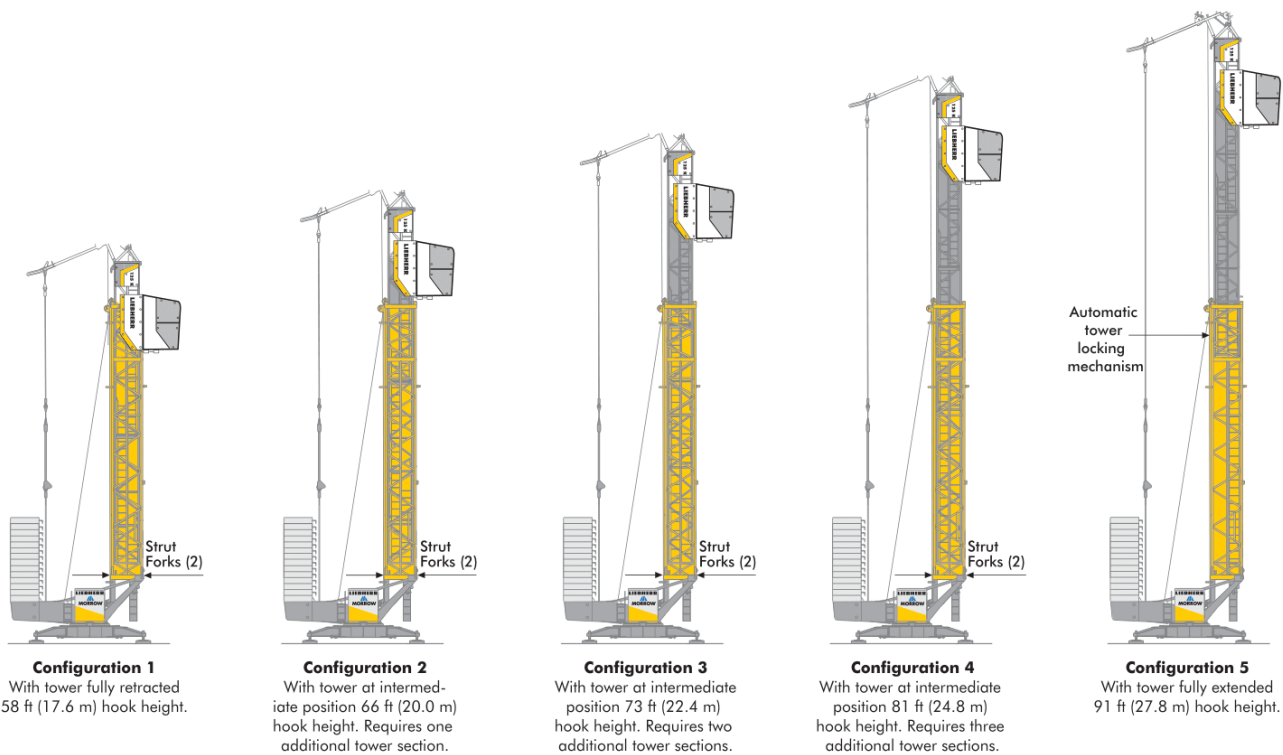

Tower Configurations

With tower completely extended, the crane user can add up to 5 tower sections (some restrictions exist). Ten tower configurations provide a hook height range of 58 ft (17.6 m) to 131 ft (39.8 m).

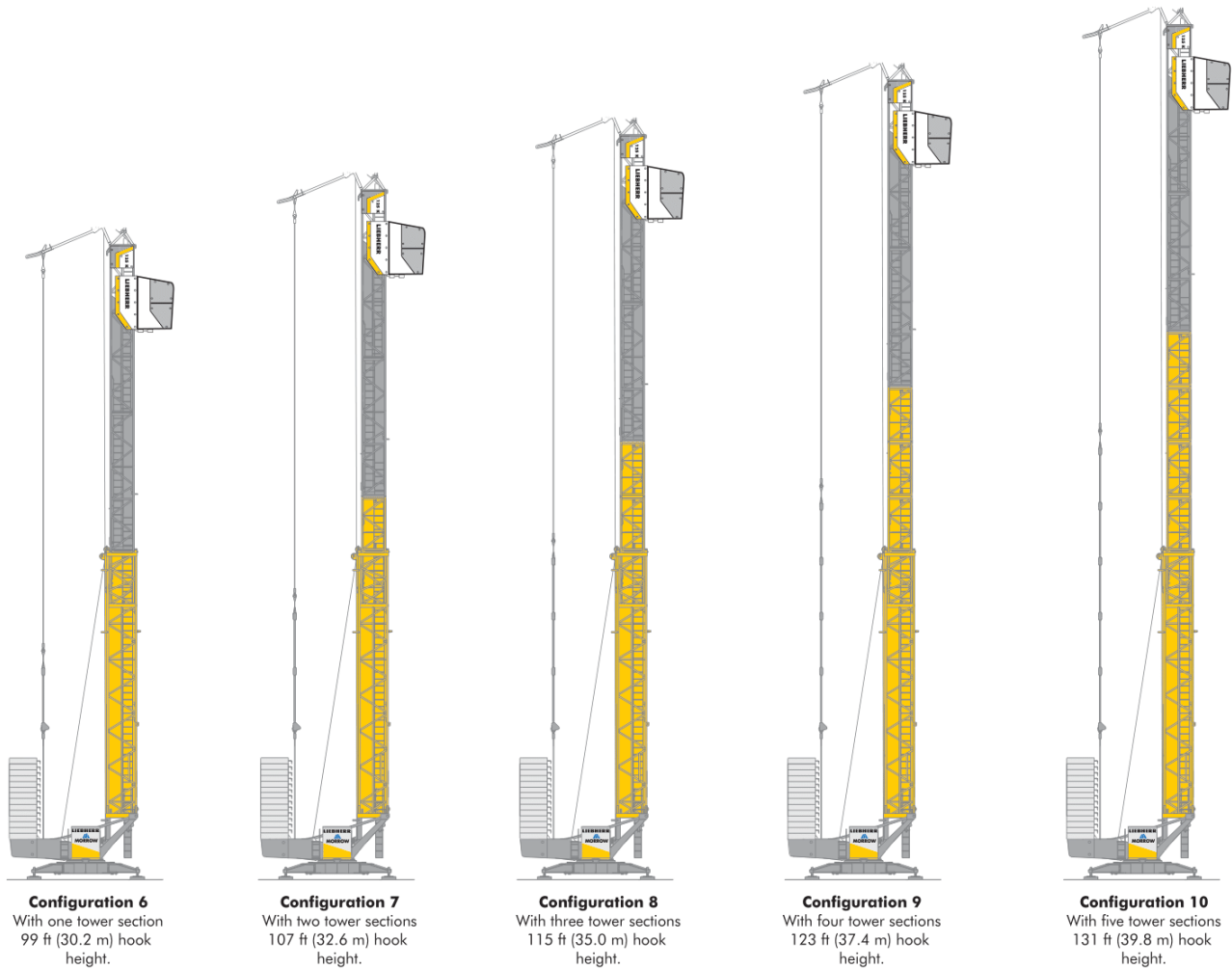

NOTE: Guying shown is for illustrative purposes only and may not indicate actual connections required. See 125 K Instruction Manual for more information.

LIEBHERR 125 K

Radius and Capacities

		LM 1																
Hook Radius	Maximum Capacity - Radius	ft m	26 8.0	39 12.0	52 16.0	66 20.0	79 24.0	92 28.0	105 32.0	115 35.0	125 38.0	131 40.0	138 42.0	148 45.0	157 48.0	164 50.0	171 52.0	180 55.0
180 ft 55.0 m	17,637 lb - 29 ft 8 000 kg - 8.9 m	lb kg	17,637 8 000	13,250 6 010	9,943 4 510	7,848 3 560	6,415 2 910	5,379 2 440	4,586 2 080	4,101 1 860	3,704 1 680	3,461 1 570	3,241 1 470	2,954 1 340	2,690 1 220	2,535 1 150	2,403 1 090	2,205 1 000
164 ft 50.0 m	17,637 lb - 34 ft 8 000 kg - 10.3 m	lb kg	17,637 8 000	15,366 6 970	11,751 5 330	9,436 4 280	7,804 3 540	6,614 3 000	5,710 2 590	5,137 2 330	4,674 2 120	4,387 1 990	4,123 1 870	3,792 1 720	3,483 1 580	3,307 1 500		
148 ft 45.0 m	17,637 lb - 40 ft 8 000 kg - 12.2 m	lb kg	17,637 8 000	17,637 8 000	13,647 6 190	10,913 4 950	9,017 4 090	7,650 3 470	6,592 2 990	5,952 2 700	5,401 2 450	5,093 2 310	4,806 2 180	4,409 2 000				
131 ft 40.0 m	17,637 lb - 48 ft 8 000 kg - 14.5 m	lb kg	17,637 8 000	17,637 8 000	15,984 7 250	12,743 5 780	10,516 4 770	8,907 4 040	7,694 3 490	6,945 3 150	6,327 2 870	5,952 2 700						
115 ft 35.0 m	17,637 lb - 53 ft 8 000 kg - 16.3 m	lb kg	17,637 8 000	17,637 8 000	17,637 8 000	14,242 6 460	11,729 5 320	9,921 4 500	8,554 3 880	7,716 3 500								

		Load-Plus*																
Hook Radius	Maximum Capacity - Radius	ft m	26 8.0	39 12.0	52 16.0	66 20.0	79 24.0	92 28.0	105 32.0	115 35.0	125 38.0	131 40.0	138 42.0	148 45.0	157 48.0	164 50.0	171 52.0	180 55.0
180 ft 55.0 m	17,637 lb - 29 ft 8 000 kg - 8.9 m	lb kg	17,637 8 000	13,933 6 320	10,913 4 950	8,885 4 030	7,430 3 370	6,349 2 880	5,512 2 500	4,982 2 260	4,542 2 060	4,277 1 940	4,034 1 830	3,704 1 680	3,417 1 550	3,241 1 470	3,086 1 400	2,866 1 300
164 ft 50.0 m	17,637 lb - 34 ft 8 000 kg - 10.3 m	lb kg	17,637 8 000	15,807 7 170	12,677 5 750	10,516 4 770	8,951 4 060	7,738 3 510	6,790 3 080	6,195 2 810	5,688 2 580	5,379 2 440	5,093 2 310	4,718 2 140	4,387 1 990	4,189 1 900		
148 ft 45.0 m	17,637 lb - 40 ft 8 000 kg - 12.2 m	lb kg	17,637 8 000	17,637 8 000	14,286 6 480	11,817 5 360	10,009 4 540	8,664 3 930	7,584 3 440	6,923 3 140	6,349 2 880	6,019 2 730	5,710 2 590	5,291 2 400				
131 ft 40.0 m	17,637 lb - 48 ft 8 000 kg - 14.5 m	lb kg	17,637 8 000	17,637 8 000	16,270 7 380	13,426 6 090	11,354 5 150	9,811 4 450	8,598 3 900	7,848 3 560	7,209 3 270	6,834 3 100						
115 ft 35.0 m	17,637 lb - 53 ft 8 000 kg - 16.3 m	lb kg	17,637 8 000	17,637 8 000	17,637 8 000	14,859 6 740	12,632 5 730	10,957 4 970	9,634 4 370	8,818 4 000								

*Load-Plus increases the lifting capacity with restrictions including wind speeds, reduced drive speeds and single function only operation. Please consult the 125 K Operations Manual for further details.

LIEBHERR 125 K

Jib Luffed at 30°

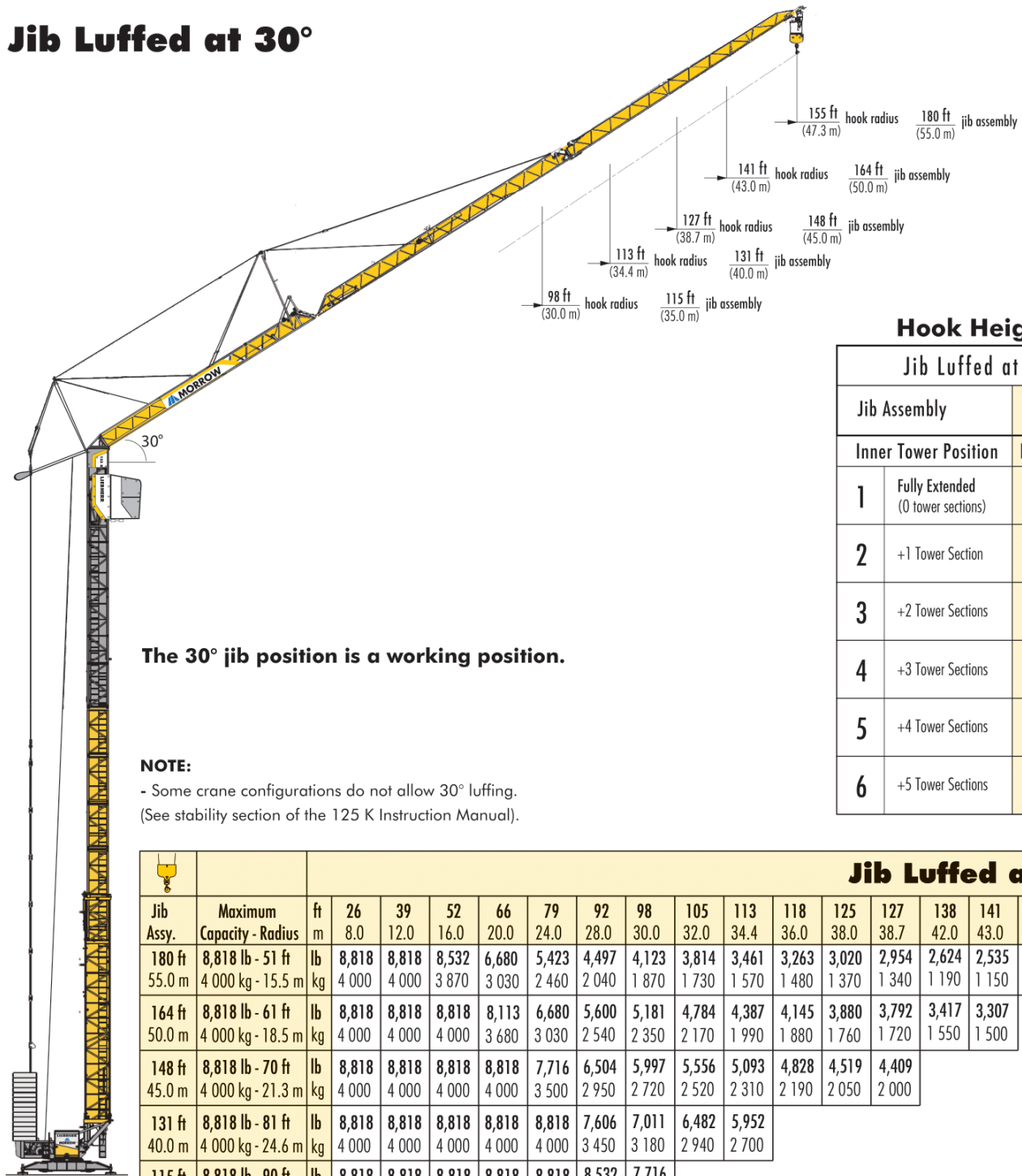

The 30° jib position is a working position.

NOTE:

- Some crane configurations do not allow 30° luffing.
(See stability section of the 125 K Instruction Manual).

Hook Heights

Jib Luffed at 30°		
Jib Assembly		180 ft 55.0 m
Inner Tower Position		Hook Heights
1	Fully Extended (0 tower sections)	176 ft 53.5 m
2	+1 Tower Section	183 ft 55.9 m
3	+2 Tower Sections	191 ft 58.3 m
4	+3 Tower Sections	199 ft 60.7 m
5	+4 Tower Sections	207 ft 63.1 m
6	+5 Tower Sections	215 ft 65.5 m

		Jib Luffed at 30°																
Jib Assy.	Maximum Capacity - Radius	ft m	26 8.0	39 12.0	52 16.0	66 20.0	79 24.0	92 28.0	98 30.0	105 32.0	113 34.4	118 36.0	125 38.0	127 38.7	138 42.0	141 43.0	151 46.0	155 47.3
180 ft 55.0 m	8,818 lb - 51 ft 4 000 kg - 15.5 m	lb kg	8,818 4 000	8,818 4 000	8,532 3 870	6,680 3 030	5,423 2 460	4,497 2 040	4,123 1 870	3,814 1 730	3,461 1 570	3,263 1 480	3,020 1 370	2,954 1 340	2,624 1 190	2,535 1 150	2,293 1 040	2,205 1 000
164 ft 50.0 m	8,818 lb - 61 ft 4 000 kg - 18.5 m	lb kg	8,818 4 000	8,818 4 000	8,818 4 000	8,113 3 680	6,680 3 030	5,600 2 540	5,181 2 350	4,784 2 170	4,387 1 990	4,145 1 880	3,880 1 760	3,792 1 720	3,417 1 550	3,307 1 500		
148 ft 45.0 m	8,818 lb - 70 ft 4 000 kg - 21.3 m	lb kg	8,818 4 000	8,818 4 000	8,818 4 000	8,818 4 000	7,716 3 500	6,504 2 950	5,997 2 720	5,556 2 520	5,093 2 310	4,828 2 190	4,519 2 050	4,409 2 000				
131 ft 40.0 m	8,818 lb - 81 ft 4 000 kg - 24.6 m	lb kg	8,818 4 000	8,818 4 000	8,818 4 000	8,818 4 000	8,818 4 000	7,606 3 450	7,011 3 180	6,482 2 940	5,952 2 700							
115 ft 35.0 m	8,818 lb - 90 ft 4 000 kg - 27.4 m	lb kg	8,818 4 000	8,818 4 000	8,818 4 000	8,818 4 000	8,818 4 000	8,532 3 870	7,716 3 500									

LIEBHERR 125 K

Jib Tip Clearances at 45°

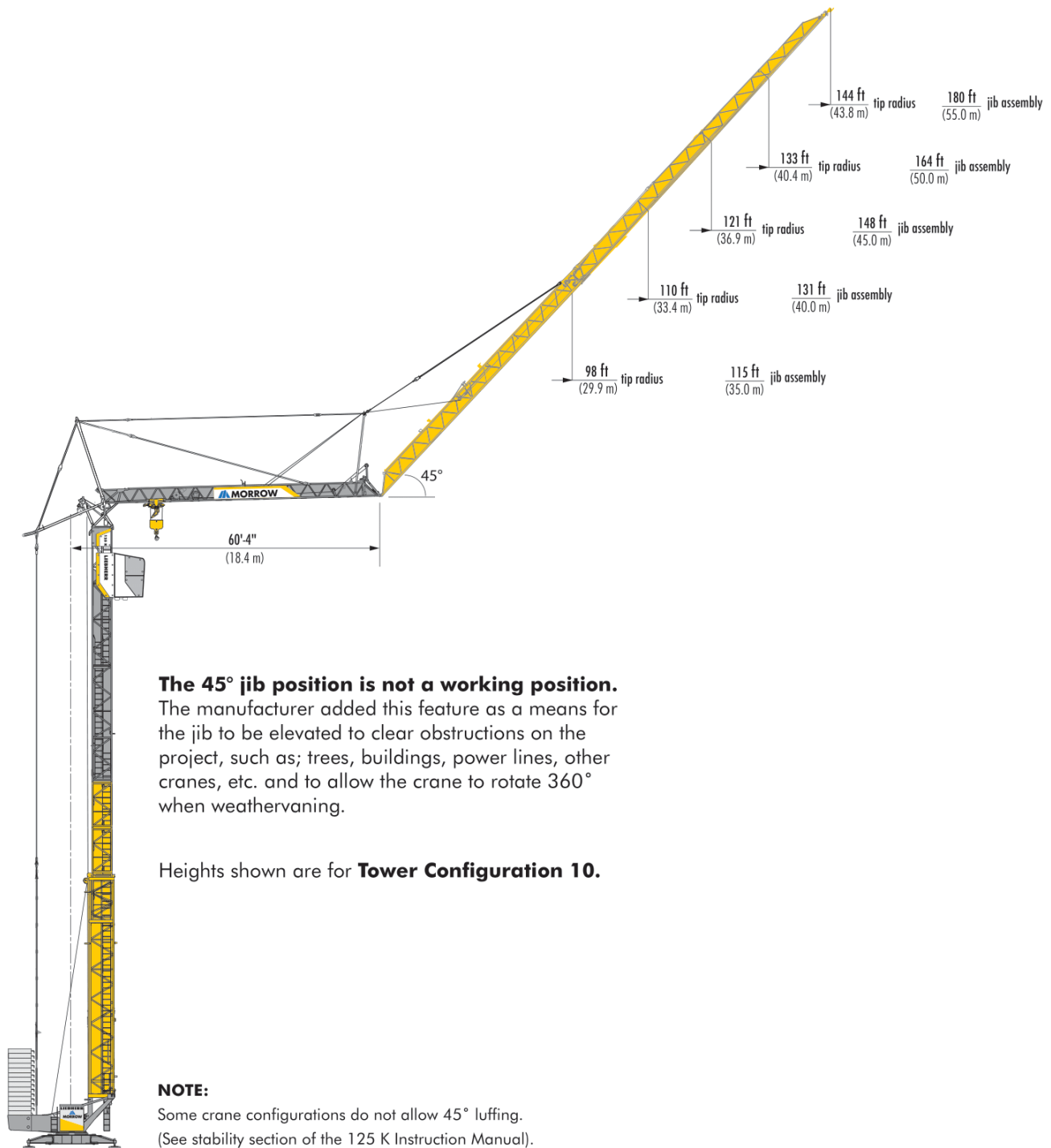

LIEBHERR 125 K

Erecting Clearances

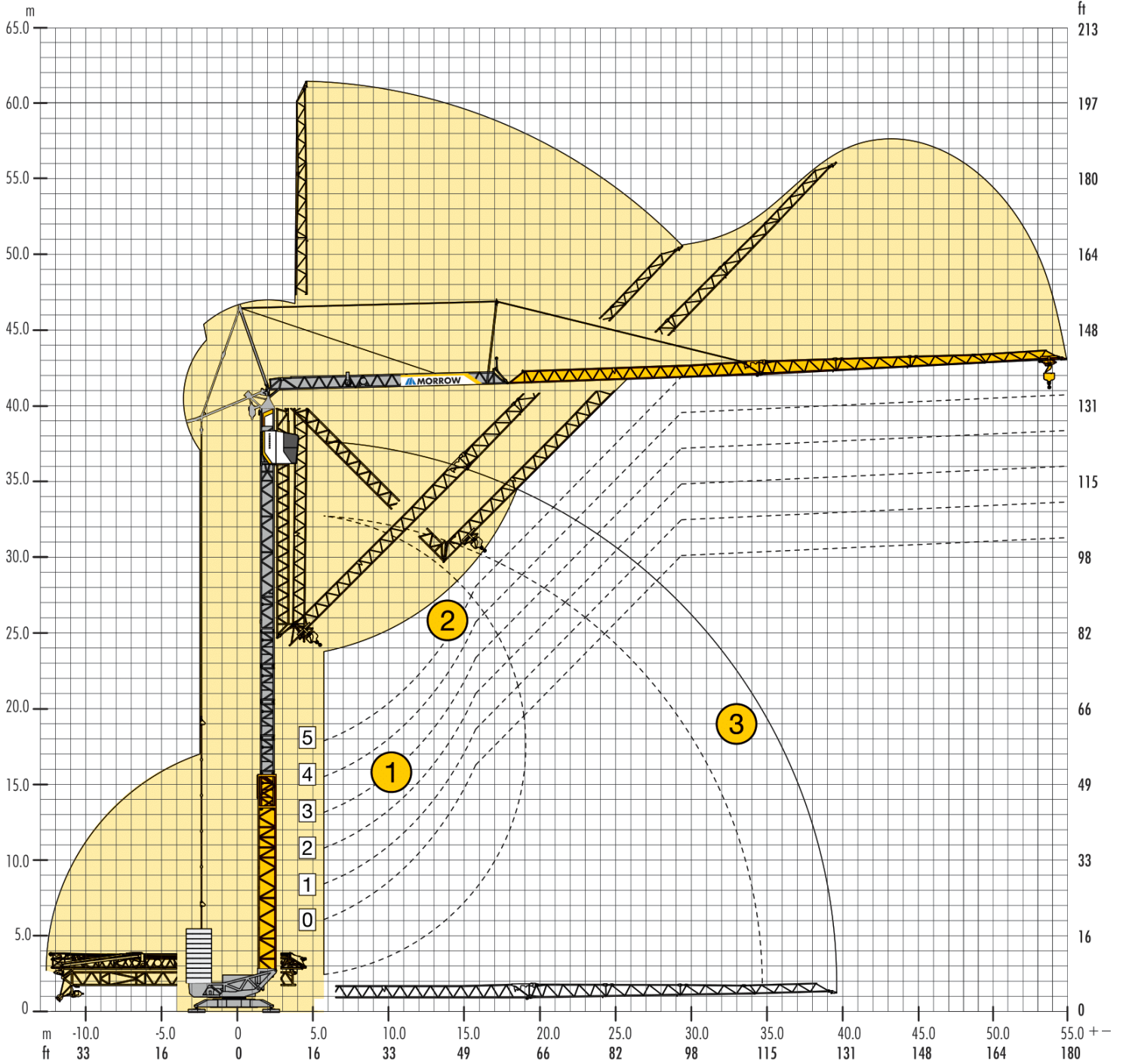

- ① Standard erecting curves from 0 to 5 tower sections.
- ② Elevated erecting curve (+14'-9") using the example of 5 tower sections.
- ③ Erecting curve 180 ft (55.0 m) radius.

IMPORTANT: Consult 125 K Instruction Manual before erecting, operating, servicing and dismantling crane.

LIEBHERR 125 K

Counterweight and Clearances

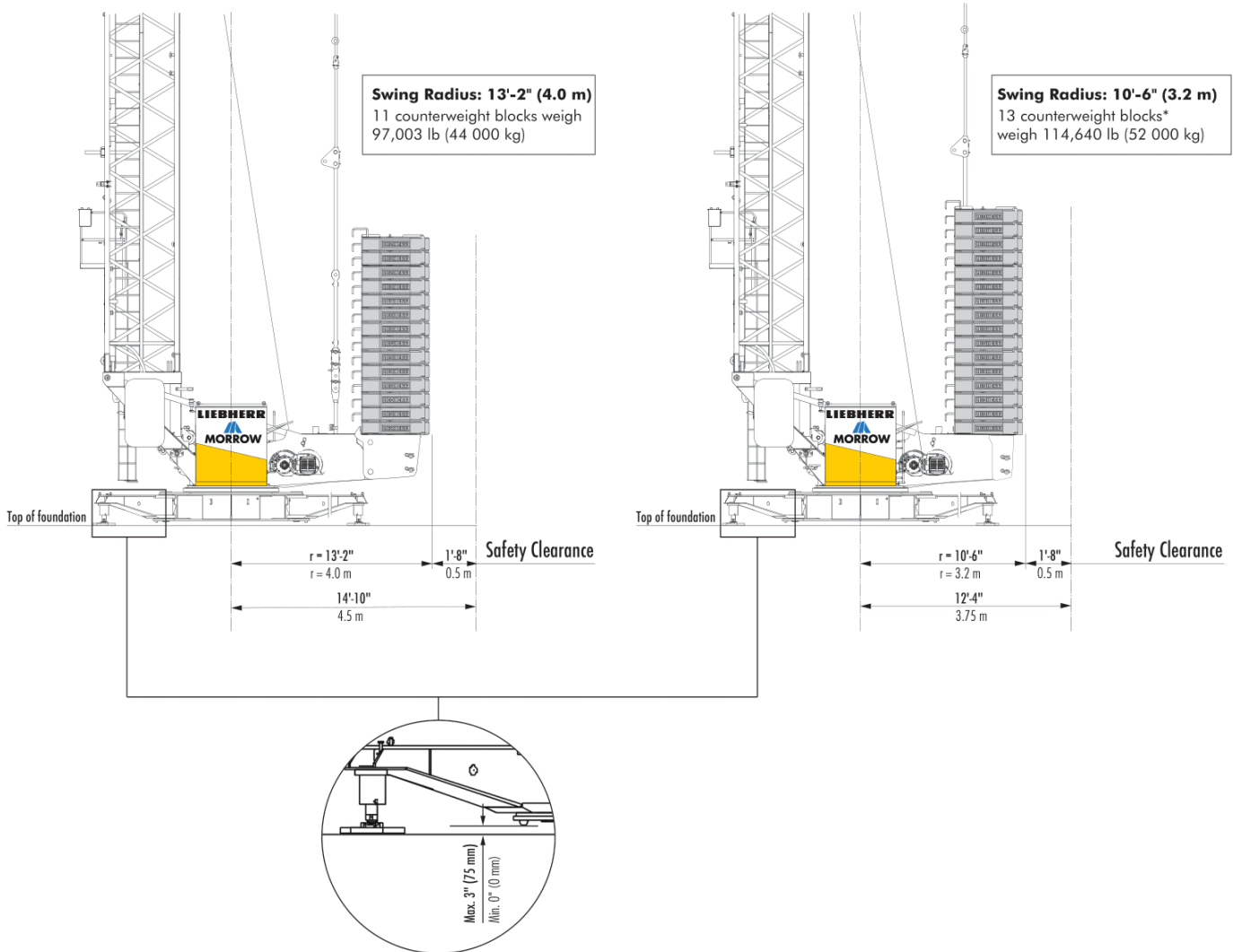

Counterweight Type	Counterweight Weight	Swing Radius	Quantity + Total Weight
Concrete Block	8,818 lb (4 000 kg)	13'-2" (4.0 m)	11 blocks = 97,003 lb (44 000 kg)
		10'-6" (3.2 m)	13 blocks = 114,640 lb (52 000 kg)

Swing Radius

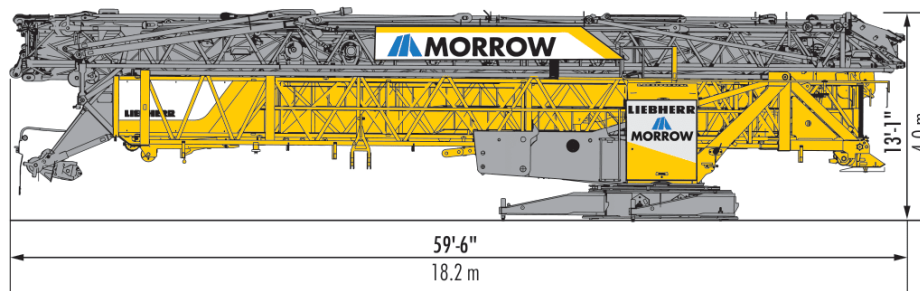
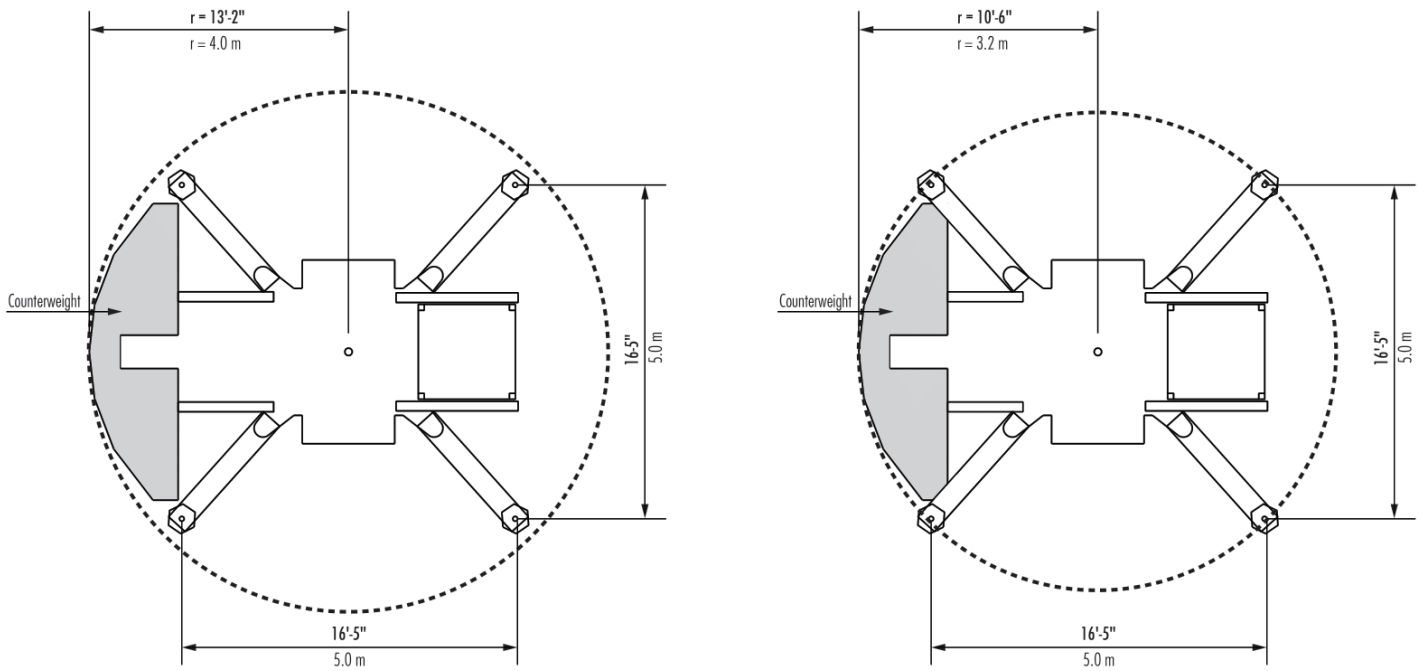

56,879 lb (25,800 kg)

LIEBHERR 125 K

Hoist Speed and Capacity

Hoist Drive	WiW 220 MZ 402		2-Part Line			
	Speed	Capacity	Hook Speed	Capacity	Hook Speed	
24 hp (18 kW) AC hoist unit Variable frequency drive (VFD) Single-speed gearbox	1	17,637 lb	@ 39 ft/min	8 000 kg	@ 11.8 m/min	
		1,213 lb	@ 218 ft/min	550 kg	@ 66.3 m/min	

Drive Information

Drive Unit (VFD)	Horsepower	Kilowatts	Speed	
Trolley	5	3.7	0 - 233 ft/min	0 - 71 m/min
Swing	6.7	7.5	0.8 rpm	
Luffing	4	4.0	0° - 45° in 105 secs.	

Power Requirements

Power supply: 3-phase 480 V, 60 Hz; 3-wire plus ground; no Neutral;
480 V phase-phase, 277 V each phase to ground with 120° phase shift between phases;





Service size: 60 Amperes

NOTES:

1. For electric power provided by an electric utility, do not use open Delta transformers.
2. For electric power provided by a generator, the minimum generator size required is 50kW. Verify the generator provided is suitable for use with variable frequency drives (VFDs). A properly sized generator is critical to the safe operation of the crane.

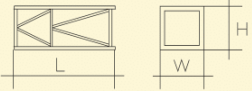
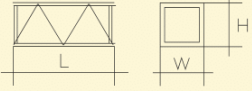
Specifications subject to change without prior notice. For additional information, contact MORROW.

Components

Description		Dimensions L x W x H	Wt.
Tower section with climbing support		8'-2" x 3'-7" x 3'-1" 2.50 m x 1.10 m x 0.95 m	1,874 lb 850 kg
Tower section without climbing support		8'-2" x 3'-7" x 3'-1" 2.50 m x 1.10 m x 0.95 m	1,433 lb 650 kg
Jib extension 115 ft to 131 ft radius		18'-0" x 3'-1" x 3'-5" 5.5 m x 0.95 m x 1.05 m	728 lb 330 kg
Jib extension 131 ft to 148 ft radius		17'-1" x 3'-1" x 3'-1" 5.2 m x 0.95 m x 0.95 m	441 lb 200 kg
Jib extension 148 ft to 164 ft radius		17'-1" x 3'-1" x 2'-5" 5.2 m x 0.95 m x 0.75 m	353 lb 160 kg
Jib extension 164 ft to 180 ft radius		19'-2" x 3'-1" x 2'-2" 5.85 m x 0.95 m x 0.65 m	287 lb 130 kg

NOTE: Weights and dimensions are approximate. Scale components before lifting. Consult 125 K Instruction Manual before erecting, operating, servicing and dismantling crane.

Specifications are subject to change without prior notice. Drawings shown in this datasheet are for illustrative purposes only. Refer to the 125 K Instruction Manual. For additional information, contact MORROW. All rights reserved.